

### FEATURES

- High integration:**
  - 32-channel DAC in 12 mm × 12 mm CSPBGA
- Adjustable voltage output range**
- Guaranteed monotonic**
- Readback capability**
- DSP/microcontroller compatible serial interface**
- Output impedance:**
  - 0.5 Ω (AD5532-1, AD5532-2)
  - 500 Ω (AD5532-3)
  - 1 kΩ (AD5532-5)
- Output voltage span:**
  - 10 V (AD5532-1, AD5532-3, AD5532-5)
  - 20 V (AD5532-2)
- Infinite sample-and-hold capability to ±0.018% accuracy**
- Temperature range –40°C to +85°C**

### APPLICATIONS

- Automatic test equipment
- Optical networks
- Level setting
- Instrumentation
- Industrial control systems
- Data acquisition
- Low cost I/O

### GENERAL DESCRIPTION

The AD5532<sup>1</sup> is a 32-channel, 14-bit voltage-output DAC with an additional infinite sample-and-hold mode. The selected DAC register is written to via the 3-wire serial interface;  $V_{OUT}$  for this DAC is then updated to reflect the new contents of the DAC register. DAC selection is accomplished via Address Bits A0–A4. The output voltage range is determined by the offset voltage at the OFFS\_IN pin and the gain of the output amplifier. It is restricted to a range from  $V_{SS} + 2\text{ V}$  to  $V_{DD} - 2\text{ V}$  because of the headroom of the output amplifier.

The device is operated with  $AV_{CC} = 5\text{ V} \pm 5\%$ ;  $DV_{CC} = 2.7\text{ V}$  to  $5.25\text{ V}$ ;  $V_{SS} = -4.75\text{ V}$  to  $-16.5\text{ V}$ ; and  $V_{DD} = 8\text{ V}$  to  $16.5\text{ V}$ . The AD5532 requires a stable 3 V reference on REF\_IN as well as an offset voltage on OFFS\_IN.

### PRODUCT HIGHLIGHTS

1. 32-channel, 14-bit DAC in one package, guaranteed monotonic.
2. Available in a 74-lead CSPBGA package with a body size of 12 mm × 12 mm.
3. Droopless/infinite sample-and-hold mode.

<sup>1</sup> Protected by U.S. Patent No. 5,969,657; other patents pending.

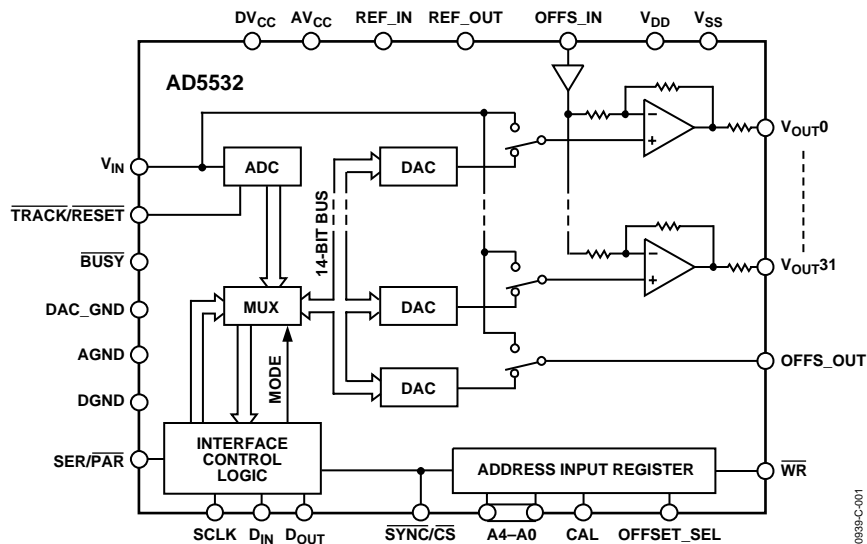

Figure 1. Functional Block Diagram

### Rev. C

Information furnished by Analog Devices is believed to be accurate and reliable. However, no responsibility is assumed by Analog Devices for its use, nor for any infringements of patents or other rights of third parties that may result from its use. Specifications subject to change without notice. No license is granted by implication or otherwise under any patent or patent rights of Analog Devices. Trademarks and registered trademarks are the property of their respective owners.

## TABLE OF CONTENTS

Specifications.....	3	Offset Voltage Channel.....	14
ISHA Mode.....	5	Reset Function.....	14
Timing Characteristics.....	6	ISHA Mode.....	14
Parallel Interface.....	6	Analog Input (ISHA Mode).....	14
Parallel Interface Timing Diagrams.....	6	$\overline{\text{TRACK}}$ Function (ISHA Mode).....	15
Serial Interface.....	7	Modes of Operation.....	15
Absolute Maximum Ratings.....	8	Serial Interface.....	16
Pin Configuration and Function Descriptions.....	9	Parallel Interface (ISHA Mode Only).....	17
Terminology.....	11	Microprocessor Interfacing.....	17
Dac Mode.....	11	Application Circuits.....	18
ISHA Mode.....	11	Power Supply Decoupling.....	19
Typical Performance Characteristics.....	12	Outline Dimensions.....	20
Functional Description.....	14	Ordering Guide.....	20
Output Buffer Stage—Gain and Offset.....	14		

## REVISION HISTORY

### 6/04—Data Sheet Changed from Rev. B to Rev. C

Updated Format.....	Universal
Changed LFBGA to CSPBGA.....	Universal
Changes to Outline Dimensions.....	24
Changes to Ordering Guide.....	24

### 6/02—Data Sheet Changed from Rev. A to Rev. B

Term SHA changed to ISHA.....	Global
Changes to Absolute Maximum Ratings.....	6
Changes to Ordering Guide.....	6
Changes to Functional Description.....	11
Changes to Table 8.....	11
Changes to ISHA Mode.....	11
Added Figure 27 and accompanying text.....	15
Changes to Power Supply Decoupling Section.....	15

## SPECIFICATIONS

$V_{DD} = 8\text{ V to }16.5\text{ V}$ ,  $V_{SS} = -4.75\text{ V to }-16.5\text{ V}$ ;  $AV_{CC} = 4.75\text{ V to }5.25\text{ V}$ ;  $DV_{CC} = 2.7\text{ V to }5.25\text{ V}$ ;  $AGND = DGND = DAC\_GND = 0\text{ V}$ ;  $REF\_IN = 3\text{ V}$ ; output range from  $V_{SS} + 2\text{ V to }V_{DD} - 2\text{ V}$ . All outputs unloaded. All specifications  $T_{MIN}$  to  $T_{MAX}$ , unless otherwise noted.

Table 1.

Parameter <sup>2</sup>	A Version <sup>1</sup>		Unit	Conditions/Comments
	AD5532-1/-3/-5	AD5532-2 Only		
<b>DAC DC PERFORMANCE</b>				
Resolution	14	14	Bits	
Integral Nonlinearity (INL)	$\pm 0.39$	$\pm 0.39$	% of FSR max	$\pm 0.15\%$ typ
Differential Nonlinearity (DNL)	$\pm 1$	$\pm 1$	LSB max	$\pm 0.5$ LSB typ, monotonic
Offset	90/170/250	180/350/500	mV min/typ/max	See Figure 8
Gain	3.52	7	typ	
Full Scale Error	$\pm 2$	$\pm 2$	% of FSR max	
<b>VOLTAGE REFERENCE</b>				
REF_IN				
Nominal Input Voltage	3.0	3.0	V typ	
Input Voltage Range <sup>3</sup>	2.85/3.15	2.85/3.15	V min/max	
Input Current	1	1	$\mu\text{A}$ max	$< 1\text{ nA}$ typ
REF_OUT				
Output Voltage	3	3	V typ	
Output Impedance <sup>3</sup>	280	280	k $\Omega$ typ	
Reference Temperature Coefficient <sup>3</sup>	60	60	ppm/ $^{\circ}\text{C}$ typ	
<b>ANALOG OUTPUTS (<math>V_{OUT}</math> 0–31)</b>				
Output Temperature Coefficient <sup>3, 4</sup>	10	10	ppm/ $^{\circ}\text{C}$ typ	
DC Output Impedance <sup>3</sup>				
AD5532-1	0.5	0.5	$\Omega$ typ	
AD5532-3	500		$\Omega$ typ	
AD5532-5	1		k $\Omega$ typ	
Output Range	$V_{SS} + 2/V_{DD} - 2$	$V_{SS} + 2/V_{DD} - 2$	V min/max	
Resistive Load <sup>3, 5</sup>	5	5	k $\Omega$ min	
Capacitive Load <sup>3, 5</sup>				
AD5532-1	500	500	pF max	
AD5532-3	15		nF max	
AD5532-5	40		nF max	
Short-Circuit Current <sup>3</sup>	7	7	mA typ	
DC Power-Supply Rejection Ratio <sup>3</sup>				
	-70	-70	dB typ	$V_{DD} = +15\text{ V} \pm 5\%$
	-70	-70	dB typ	$V_{SS} = -15\text{ V} \pm 5\%$
DC Crosstalk <sup>3</sup>	250	1800	$\mu\text{V}$ max	
<b>ANALOG OUTPUT (OFFS_OUT)</b>				
Output Temperature Coefficient <sup>3, 4</sup>	10	10	ppm/ $^{\circ}\text{C}$ typ	
DC Output Impedance <sup>3</sup>	1.3	1.3	k $\Omega$ typ	
Output Range	50 to REF_IN-12	50 to REF_IN-12	mV typ	
Output Current	10	10	$\mu\text{A}$ max	Source current
Capacitive Load	100	100	pF max	
<b>DIGITAL INPUTS<sup>3</sup></b>				
Input Current	$\pm 10$	$\pm 10$	$\mu\text{A}$ max	$\pm 5\text{ }\mu\text{A}$ typ
Input Low Voltage				
	0.8	0.8	V max	$DV_{CC} = 5\text{ V} \pm 5\%$
	0.4	0.4	V max	$DV_{CC} = 3\text{ V} \pm 10\%$
Input High Voltage				
	2.4	2.4	V min	$DV_{CC} = 5\text{ V} \pm 5\%$
	2.0	2.0	V min	$DV_{CC} = 3\text{ V} \pm 10\%$
Input Hysteresis (SCLK and $\overline{\text{CS}}$ Only)	200	200	mV typ	

# AD5532

Parameter <sup>2</sup>	A Version <sup>1</sup>		Unit	Conditions/Comments
	AD5532-1/-3/-5	AD5532-2 Only		
Input Capacitance	10	10	pF max	
<b>DIGITAL OUTPUTS (BUSY, D<sub>OUT</sub>)<sup>3</sup></b>				
Output Low Voltage, DV <sub>CC</sub> = 5 V	0.4	0.4	V max	Sinking 200 μA.
Output High Voltage, DV <sub>CC</sub> = 5 V	4.0	4.0	V min	Sourcing 200 μA.
Output Low Voltage, DV <sub>CC</sub> = 3 V	0.4	0.4	V max	Sinking 200 μA.
Output High Voltage, DV <sub>CC</sub> = 3 V	2.4	2.4	V min	Sourcing 200 μA.
High Impedance Leakage Current	±1	±1	μA max	D <sub>OUT</sub> only.
High Impedance Output Capacitance	15	15	pF typ	D <sub>OUT</sub> only.
<b>POWER REQUIREMENTS</b>				
Power-Supply Voltages				
V <sub>DD</sub>	8/16.5	8/16.5	V min/max	
V <sub>SS</sub>	-4.75/-16.5	-4.75/-16.5	V min/max	
AV <sub>CC</sub>	4.75/5.25	4.75/5.25	V min/max	
DV <sub>CC</sub>	2.7/5.25	2.7/5.25	V min/max	
Power-Supply Currents <sup>6</sup>				
I <sub>DD</sub>	15	15	mA max	10 mA typ. All channels full scale.
I <sub>SS</sub>	15	15	mA max	10 mA typ. All channels full scale.
AICC	33	33	mA max	26 mA typ.
DICC	1.5	1.5	mA max	1 mA typ.
Power Dissipation <sup>6</sup>	280	280	mW typ	V <sub>DD</sub> = 10 V, V <sub>SS</sub> = -5 V.
<b>AC CHARACTERISTICS<sup>3</sup></b>				
Output Voltage Settling Time	22	30	μs max	500 pF, 5 kΩ load. Full-scale change.
OFFS_IN Settling Time	10	25	μs max	500 pF, 5 kΩ load; 0 V to 3 V step.
Digital-to-Analog Glitch Impulse	1	1	nV-s typ	1 LSB change around. Major carry.
Digital Crosstalk	5	5	nV-s typ	
Analog Crosstalk	1	1	nV-s typ	
Digital Feedthrough	0.2	0.2	nV-s typ	
Output Noise Spectral Density @ 1 kHz	400	400	nV/(√Hz) typ	

<sup>1</sup> A version: Industrial temperature range -40°C to +85°C; typical at +25°C.

<sup>2</sup> See Terminology section.

<sup>3</sup> Guaranteed by design and characterization, not production tested.

<sup>4</sup> AD780 as reference for the AD5532.

<sup>5</sup> Ensure that you do not exceed T<sub>J</sub> (max). See Absolute Maximum Ratings section.

<sup>6</sup> Output unloaded.

## ISHA MODE

Table 2.

Parameter <sup>2</sup>	A Version <sup>1</sup>		Unit	Conditions/Comments
	AD5532-1/-3/-5	AD5532-2 Only		
ANALOG CHANNEL				
$V_{IN}$ to $V_{OUT}$ Nonlinearity <sup>3</sup>	±0.018	±0.018	% max	±0.006% typ after offset and gain adjustment.
Offset Error	±50	±75	mV max	±10 mV typ. See Figure 9.
Gain	3.46/3.52/3.6	6.96/7/7.02	min/typ/max	See Figure 9
ANALOG INPUT ( $V_{IN}$ )				
Input Voltage Range	0 to 3	0 to 3	V	Nominal input range.
Input Lower Dead Band	70	70	mV max	50 mV typ. Referred to $V_{IN}$ . See Figure 9.
Input Upper Dead Band	40	40	mV max	12 mV typ. Referred to $V_{IN}$ . See Figure 9.
Input Current	1	1	µA max	100 nA typ.
Input Capacitance <sup>4</sup>	20	20	pF typ	$V_{IN}$ acquired on 1 channel.
ANALOG INPUT (OFFS_IN)				
Input Current	1	1	µA max	100 nA typ.
Input Voltage Range	0/4	0/4	Vmin/max	Output range restricted from $V_{SS} + 2 V$ to $V_{DD} - 2 V$ .
AC CHARACTERISTICS				
Output Settling Time <sup>4</sup>	3	3	µs max	Output unloaded.
Acquisition Time	16	16	µs max	
AC Crosstalk <sup>4</sup>	5	5	nV-s typ	

<sup>1</sup> A version: Industrial temperature range -40°C to +85°C; typical at +25°C.

<sup>2</sup> See Terminology section.

<sup>3</sup> Input range 100 mV to 2.96 V.

<sup>4</sup> Guaranteed by design and characterization, not production tested.

## TIMING CHARACTERISTICS

### PARALLEL INTERFACE

Table 3.

Parameter <sup>1, 2</sup>	Limit at T <sub>MIN</sub> , T <sub>MAX</sub> (A Version)	Unit	Conditions/Comments
t <sub>1</sub>	0	ns min	$\overline{\text{CS}}$ to $\overline{\text{WR}}$ setup time
t <sub>2</sub>	0	ns min	$\overline{\text{CS}}$ to $\overline{\text{WR}}$ hold time
t <sub>3</sub>	50	ns min	$\overline{\text{CS}}$ pulse width low
t <sub>4</sub>	50	ns min	$\overline{\text{WR}}$ pulse width low
t <sub>5</sub>	20	ns min	A4–A0, CAL, OFFS_SEL to $\overline{\text{WR}}$ setup time
t <sub>6</sub>	7	ns min	A4–A0, CAL, OFFS_SEL to $\overline{\text{WR}}$ hold time

<sup>1</sup> See Figure 2 and Figure 3, the parallel interface timing diagrams.

<sup>2</sup> Guaranteed by design and characterization, not production tested.

### PARALLEL INTERFACE TIMING DIAGRAMS

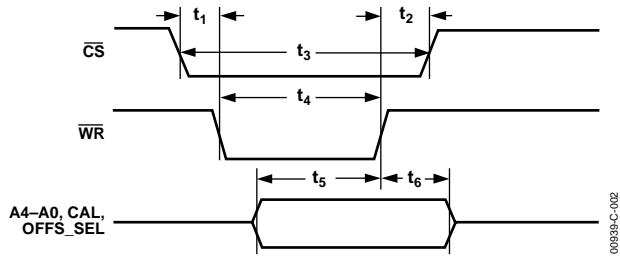

Figure 2. Parallel Write (ISHA Mode Only)

00038-C-002

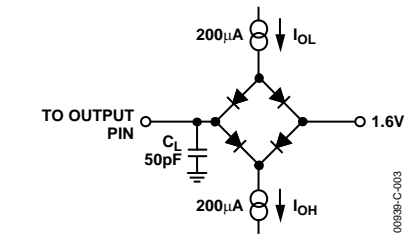

Figure 3. Load Circuit for D<sub>OUT</sub> Timing Specifications

00038-C-003

SERIAL INTERFACE

Table 4.

Parameter <sup>1, 2</sup>	Limit at T <sub>MIN</sub> , T <sub>MAX</sub> (A Version)	Unit	Conditions/Comments
f <sub>CLKIN</sub> <sup>3</sup>	14	MHz max	SCLK frequency
t <sub>1</sub>	28	ns min	SCLK high pulse width
t <sub>2</sub>	28	ns min	SCLK low pulse width
t <sub>3</sub>	15	ns min	$\overline{\text{SYNC}}$ falling edge to SCLK falling edge setup time
t <sub>4</sub>	50	ns min	$\overline{\text{SYNC}}$ low time
t <sub>5</sub>	10	ns min	D <sub>IN</sub> setup time
t <sub>6</sub>	5	ns min	D <sub>IN</sub> hold time
t <sub>7</sub>	5	ns min	$\overline{\text{SYNC}}$ falling edge to SCLK rising edge setup time for read back
t <sub>8</sub> <sup>4</sup>	20	ns max	SCLK rising edge to D <sub>OUT</sub> valid
t <sub>9</sub>	60	ns max	SCLK falling edge to D <sub>OUT</sub> high impedance
t <sub>10</sub>	400	ns min	10th SCLK falling edge to $\overline{\text{SYNC}}$ falling edge for read back
t <sub>11</sub>	400	ns min	24th SCLK falling edge to $\overline{\text{SYNC}}$ falling edge for DAC mode write
t <sub>12</sub> <sup>5</sup>	7	ns min	SCLK falling edge to $\overline{\text{SYNC}}$ falling edge setup time for read back

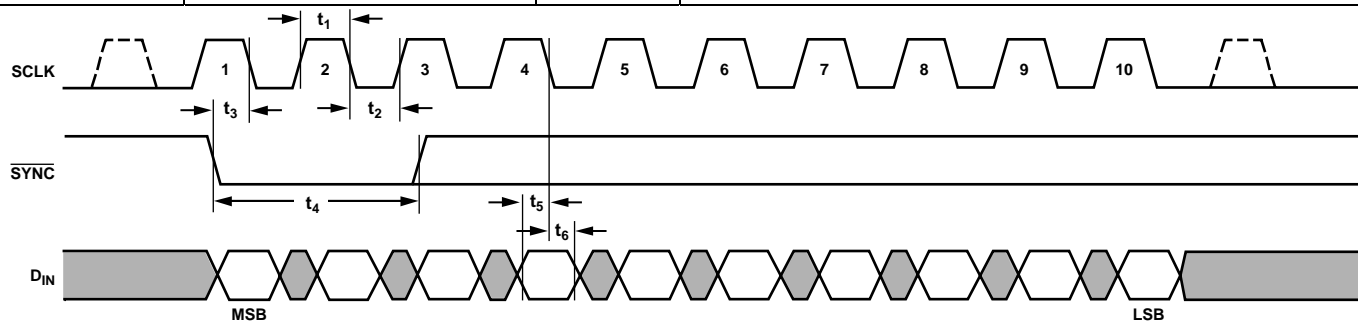

Figure 4. 10-Bit Write (ISHA Mode and Both Readback Modes)

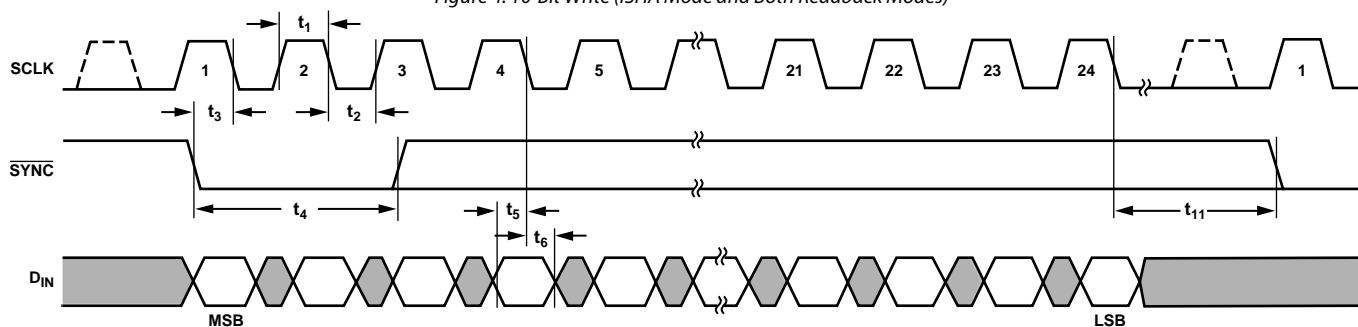

Figure 5. 24-Bit Write (DAC Mode)

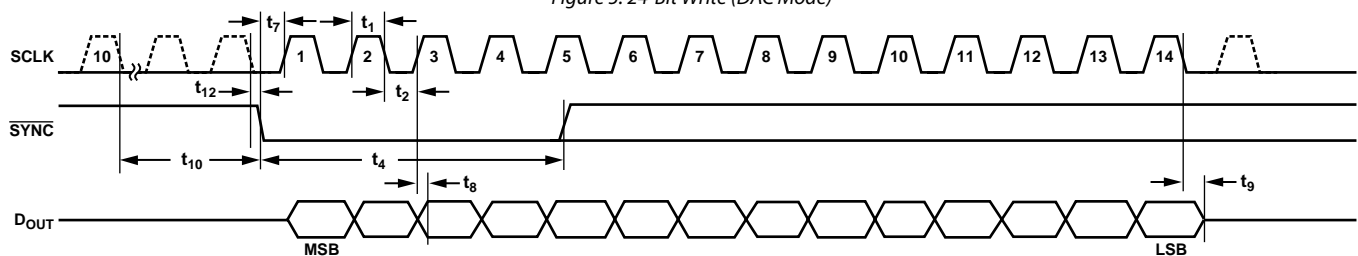

Figure 6. 14-Bit Read (Both Readback Modes)

<sup>1</sup> See Figure 4, Figure 5, and Figure 6.

<sup>2</sup> Guaranteed by design and characterization, not production tested.

<sup>3</sup> In ISHA mode the maximum SCLK frequency is 20 MHz and the minimum pulse width is 20 ns.

<sup>4</sup> These numbers are measured with the load circuit of Figure 3.

<sup>5</sup> SYNC should be taken low while SCLK is low for read back.

## ABSOLUTE MAXIMUM RATINGS

Stresses above those listed under Absolute Maximum Ratings may cause permanent damage to the device. This is a stress rating only; functional operation of the device at these or any other conditions above those listed in the operational sections of this specification is not implied. Exposure to absolute maximum rating conditions for extended periods may affect device reliability.

T<sub>A</sub> = 25°C unless otherwise noted.

For higher junction temperatures derate as follows:

TJ (°C)	Max Continuous Load Current per Group (mA)
70	15.5
90	9.025
100	6.925
110	5.175
125	3.425
135	2.55
150	1.5

Table 5.

Parameter <sup>1</sup>	Rating
V <sub>DD</sub> to AGND	-0.3 V to +17 V
V <sub>SS</sub> to AGND	+0.3 V to -17 V
AV <sub>CC</sub> to AGND, DAC_GND	-0.3 V to +7 V
DV <sub>CC</sub> to DGND	-0.3 V to +7 V
Digital Inputs to DGND	-0.3 V to DV <sub>CC</sub> + 0.3 V
Digital Outputs to DGND	-0.3 V to DV <sub>CC</sub> + 0.3 V
REF_IN to AGND, DAC_GND	-0.3 V to AV <sub>CC</sub> + 0.3 V
V <sub>IN</sub> to AGND, DAC_GND	-0.3 V to AV <sub>CC</sub> + 0.3 V
V <sub>OUT</sub> 0-31 to AGND	V <sub>SS</sub> - 0.3 V to V <sub>DD</sub> + 0.3 V
OFFS_IN to AGND	V <sub>SS</sub> - 0.3 V to V <sub>DD</sub> + 0.3 V
OFFS_OUT to AGND	AGND - 0.3 V to AV <sub>CC</sub> + 0.3 V
AGND to DGND	-0.3 V to +0.3 V
Operating Temperature Range	
Industrial	-40°C to +85°C
Storage Temperature Range	-65°C to +150°C
Junction Temperature (T <sub>J</sub> max)	150°C
74-Lead CSPBGA Package, θ <sub>JA</sub> Thermal Impedance	41°C/W
Reflow Soldering	
Peak Temperature	220°C
Time at Peak Temperature	10 sec to 40 sec
Max Power Dissipation	(150°C - T <sub>A</sub> )/θ <sub>JA</sub> mW <sup>2</sup>
Max Continuous Load Current at T <sub>J</sub> = 70°C, per Channel Group	15 mA <sup>3</sup>

<sup>1</sup> Transient currents of up to 100 mA do not cause SCR latch-up.

<sup>2</sup> This limit includes load power.

<sup>3</sup> This maximum allowed continuous load current is spread over 8 channels and channels are grouped as follows:

Group 1: Channels 3, 4, 5, 6, 7, 8, 9, 10

Group 2: Channels 14, 16, 18, 20, 21, 24, 25, 26

Group 3: Channels 15, 17, 19, 22, 23, 27, 28, 29

Group 4: Channels 0, 1, 2, 11, 12, 13, 30, 31

## ESD CAUTION

ESD (electrostatic discharge) sensitive device. Electrostatic charges as high as 4000 V readily accumulate on the human body and test equipment and can discharge without detection. Although this product features proprietary ESD protection circuitry, permanent damage may occur on devices subjected to high energy electrostatic discharges. Therefore, proper ESD precautions are recommended to avoid performance degradation or loss of functionality.





# PIN CONFIGURATION AND FUNCTION DESCRIPTIONS

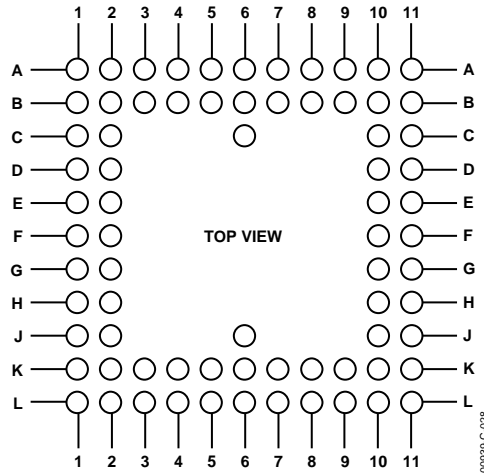

Figure 7. 74-Lead CSPBGA Ball Configuration

Table 6. 74-Lead CSPBGA Ball Configuration

CSPBGA Number	Ball Name	CSPBGA Number	Ball Name	CSPBGA Number	Ball Name
A1	Not connected	C10	AV <sub>CC</sub> 1	J10	VO9
A2	A4	C11	REF_OUT	J11	VO11
A3	A2	D1	VO20	K1	VO17
A4	A0	D2	DAC_GND2	K2	VO15
A5	$\overline{\text{CS/SYNC}}$	D10	AV <sub>CC</sub> 2	K3	VO27
A6	DV <sub>CC</sub>	D11	OFFS_OUT	K4	V <sub>SS</sub> 3
A7	SCLK	E1	VO26	K5	V <sub>SS</sub> 1
A8	OFFSET_SEL	E2	VO14	K6	V <sub>SS</sub> 4
A9	$\overline{\text{BUSY}}$	E10	AGND1	K7	V <sub>DD</sub> 2
A10	$\overline{\text{TRACK/RESET}}$	E11	OFFS_IN	K8	VO2
A11	Not connected	F1	VO25	K9	VO10
B1	VO16	F2	VO21	K10	VO13
B2	Not connected	F10	AGND2	K11	VO12
B3	A3	F11	VO6	L1	Not connected
B4	A1	G1	VO24	L2	VO28
B5	$\overline{\text{WR}}$	G2	VO8	L3	VO29
B6	DGND	G10	VO5	L4	VO30
B7	D <sub>IN</sub>	G11	VO3	L5	V <sub>DD</sub> 3
B8	CAL	H1	VO23	L6	V <sub>DD</sub> 1
B9	$\overline{\text{SER/PAR}}$	H2	VIN	L7	V <sub>DD</sub> 4
B10	DOUT	H10	VO4	L8	VO31
B11	REF_IN	H11	VO7	L9	VO0
C1	VO18	J1	VO22	L10	VO1
C2	DAC_GND1	J2	VO19	L11	Not connected
C6	Not connected	J6	V <sub>SS</sub> 2		

**Table 7. Pin Function Descriptions**

Pin	Function
AGND (1–2)	Analog GND pins.
AV <sub>CC</sub> (1–2)	Analog Supply pins. Voltage range from 4.75 V to 5.25 V.
V <sub>DD</sub> (1–4)	V <sub>DD</sub> Supply pins. Voltage range from 8 V to 16.5 V.
V <sub>SS</sub> (1–4)	V <sub>SS</sub> Supply pins. Voltage range from –4.75 V to –16.5 V.
DGND	Digital GND pins.
DV <sub>CC</sub>	Digital Supply pins. Voltage range from 2.7 V to 5.25 V.
DAC_GND (1–2)	Reference GND supply for all DACs.
REF_IN	Reference voltage for Channels 0–31.
REF_OUT	Reference Output Voltage.
V <sub>OUT</sub> (0–31)	Analog Output Voltages from the 32 channels.
V <sub>IN</sub>	Analog Input Voltage. Connect this to AGND if operating in DAC mode only.
A4–A1, A0	Parallel Interface: 5 address pins for 32 channels. A4 = MSB of channel address. A0 = LSB. Internal pull-up devices on these logic inputs. Therefore, they can be left floating and default to a logic high condition.
CAL	Parallel Interface: Control input that allows all 32 channels to acquire V <sub>IN</sub> simultaneously. Internal pull-down devices on these logic inputs. Therefore, they can be left floating and default to a logic low condition
$\overline{\text{CS/SYNC}}$	This is the active low Chip Select pin for the parallel interface and the Frame Synchronization pin for the serial interface.
$\overline{\text{WR}}$	Parallel interface: Write pin; active low. This is used in conjunction with the $\overline{\text{CS}}$ pin to address the device using the parallel interface. Internal pull-down devices on these logic inputs. Therefore, they can be left floating and default to a logic low condition.
OFFSET_SEL	Parallel interface: Offset Select pin; active high. This is used to select the offset channel. Internal pull-down devices on these logic inputs. Therefore, they can be left floating and default to a logic low condition
SCLK	Serial Clock Input for Serial Interface. This operates at clock speeds up to 14 MHz (20 MHz in ISHA mode).
D <sub>IN</sub>	Data Input for Serial Interface. Data must be valid on the falling edge of SCLK. Internal pull-up devices on these logic inputs. Therefore, they can be left floating and default to a logic high condition.
D <sub>OUT</sub>	Output from the DAC registers for read back. Data is clocked out on the rising edge of SCLK and is valid on the falling edge of SCLK.
SER/ $\overline{\text{PAR}}$	This pin allows the user to select whether the serial or parallel interface is used. If the pin is tied low, the parallel interface is used. If it is tied high, the serial interface is used. Internal pull-down devices on these logic inputs. Therefore, they can be left floating and default to a logic low condition.
OFFS_IN	Offset Input. The user can supply a voltage here to offset the output span. OFFS_OUT can also be tied to this pin if the user wants to drive this pin with the offset channel.
OFFS_OUT	Offset Output. This is the acquired/programmed offset voltage which can be tied to OFFS_IN to offset the span.
$\overline{\text{BUSY}}$	This output tells the user when the input voltage is being acquired. It goes low during acquisition and returns high when the acquisition operation is complete.
$\overline{\text{TRACK/RESET}}$	If this input is held high, V <sub>IN</sub> is acquired once the channel is addressed. While it is held low, the input to the gain/offset stage is switched directly to V <sub>IN</sub> . The addressed channel begins to acquire V <sub>IN</sub> on the rising edge of $\overline{\text{TRACK}}$ . See $\overline{\text{TRACK}}$ Input section for further information. This input can also be used as a means of resetting the complete device to its power-on-reset conditions. This is achieved by applying a low-going pulse of between 90 ns and 200 ns to this pin. See section on $\overline{\text{RESET}}$ Function for further details. Internal pull-up devices on these logic inputs. Therefore, they can be left floating and default to a logic high condition.

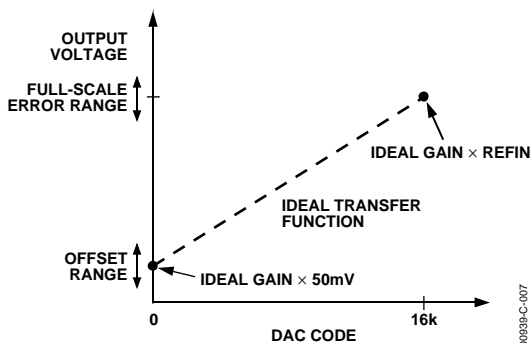

Figure 8. DAC Transfer Function (OFFS\_IN=0)

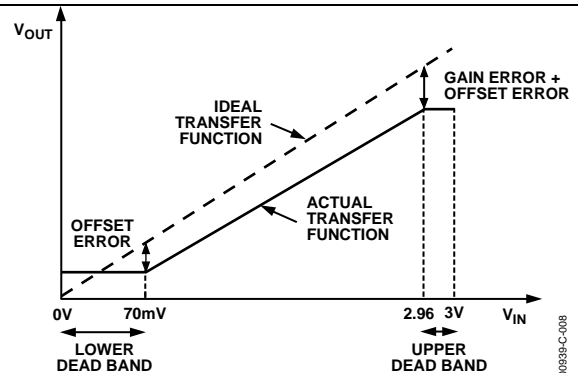

Figure 9. ISHA Transfer Function

## TERMINOLOGY

### DAC MODE

#### Integral Nonlinearity (INL)

This is a measure of the maximum deviation from a straight line passing through the endpoints of the DAC transfer function. It is expressed as a percentage of full-scale span.

#### Differential Nonlinearity (DNL)

This is the difference between the measured change and the ideal 1 LSB change between any two adjacent codes. A specified DNL of  $\pm 1$  LSB maximum ensures monotonicity.

#### Offset

Offset is a measure of the output with all zeros loaded to the DAC and  $OFFS\_IN = 0$ . Because the DAC is lifted off the ground by approximately 50 mV, this output is typically

$$V_{OUT} = Gain \times 50 \text{ mV}$$

#### Full-Scale Error

This is a measure of the output error with all 1s loaded to the DAC. It is expressed as a percentage of full-scale range. See Figure 8. It is calculated as

$$Full - Scale Error = V_{OUT(Full-Scale)} - (Ideal Gain \times REFIN)$$

where

$$Ideal Gain = 3.52 \text{ for AD5532-1/-3/-5}$$

$$Ideal Gain = 7 \text{ for AD5532-2}$$

#### Output Settling Time

This is the time taken from when the last data bit is clocked into the DAC until the output has settled to within  $\pm 0.39\%$ .

#### OFFS\_IN Settling Time

The time taken from a 0 V to 3 V step change in input voltage on  $OFFS\_IN$  until the output has settled to within  $\pm 0.39\%$ .

#### Digital-to-Analog Glitch Impulse

This is the area of the glitch injected into the analog output when the code in the DAC register changes state. It is specified as the area of the glitch in nV-secs when the digital code is changed by 1 LSB at the major carry transition (011 ... 11 to 100 ... 00 or 100 ... 00 to 011 ... 11).

#### Digital Crosstalk

This is the glitch impulse transferred to the output of one DAC at midscale while a full-scale code change (all 1s to all 0s and vice versa) is written to another DAC. It is expressed in nV-secs.

#### Analog Crosstalk

This is the area of the glitch transferred to the output ( $V_{OUT}$ ) of one DAC due to a full-scale change in the output ( $V_{OUT}$ ) of another DAC. The area of the glitch is expressed in nV-secs.

#### Digital Feedthrough

This is a measure of the impulse injected into the analog outputs from the digital control inputs when the part is not being written to, i.e.,  $\overline{CS}/\overline{SYNC}$  is high. It is specified in nV-secs and is measured with a worst-case change on the digital input pins, for example, from all 0s to all 1s and vice versa.

#### Output Noise Spectral Density

This is a measure of internally generated random noise. Random noise is characterized as a spectral density (voltage per root Hertz). It is measured by loading all DACs to midscale and measuring noise at the output. It is measured in  $nV/(\sqrt{\text{Hz}})$ .

#### Output Temperature Coefficient

This is a measure of the change in analog output with changes in temperature. It is expressed in ppm/ $^{\circ}\text{C}$ .

#### DC Power-Supply Rejection Ratio (PSRR)

DC power-supply rejection ratio is a measure of the change in analog output for a change in supply voltage ( $V_{DD}$  and  $V_{SS}$ ). It is expressed in dBs.  $V_{DD}$  and  $V_{SS}$  are varied  $\pm 5\%$ .

#### DC Crosstalk

This is the DC change in the output level of one DAC at midscale in response to a full-scale code change (all 0s to all 1s and vice versa) and an output change of all other DACs. It is expressed in  $\mu\text{V}$ .

## ISHA MODE

#### $V_{IN}$ to $V_{OUT}$ Nonlinearity

The measure of the maximum deviation from a straight line passing through the endpoints of the  $V_{IN}$  versus  $V_{OUT}$  transfer function. It is expressed as a percentage of the full-scale span.

#### Offset Error

This is a measure of the output error when  $V_{IN} = 70$  mV. Ideally, with  $V_{IN} = 70$  mV:

$$V_{OUT} = (Gain \times 70) - ((Gain - 1) \times V_{OFFS\_IN}) \text{ mV}$$

Offset error is a measure of the difference between  $V_{OUT}$  (actual) and  $V_{OUT}$  (ideal). It is expressed in mV and can be positive or negative. See Figure 9.

#### Gain Error

This is a measure of the span error of the analog channel. It is the deviation in slope of the transfer function expressed in mV. See Figure 9. It is calculated as

$$Gain Error = \frac{Actual Full-Scale Output - Ideal Full-Scale Output - Offset Error}{Ideal Full-Scale Output}$$

where:

$$Ideal Full-Scale Output = Gain \times 2.96 - ((Gain - 1) \times V_{OFFS\_IN})$$

#### AC Crosstalk

This is the area of the glitch that occurs on the output of one channel while another channel is acquiring. It is expressed in nV-secs.

#### Output Settling Time

This is the time taken from when  $\overline{BUSY}$  goes high to when the output has settled to  $\pm 0.018\%$ .

#### Acquisition Time

This is the time taken for the  $V_{IN}$  input to be acquired. It is the length of time that  $\overline{BUSY}$  stays low.

TYPICAL PERFORMANCE CHARACTERISTICS

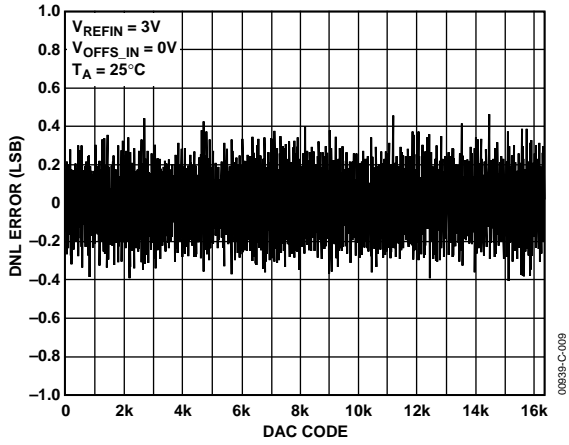

Figure 10. Typical DNL Plot

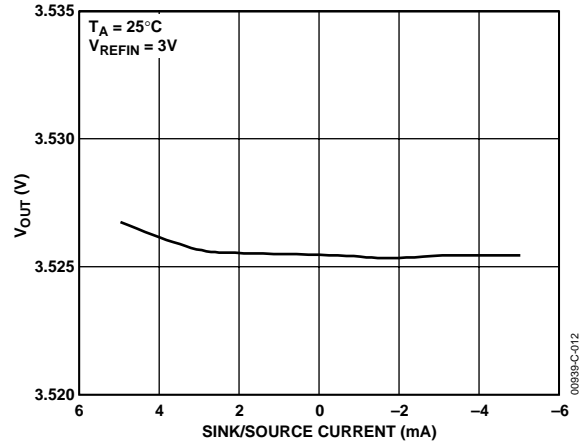

Figure 13.  $V_{out}$  Source and Sink Capability

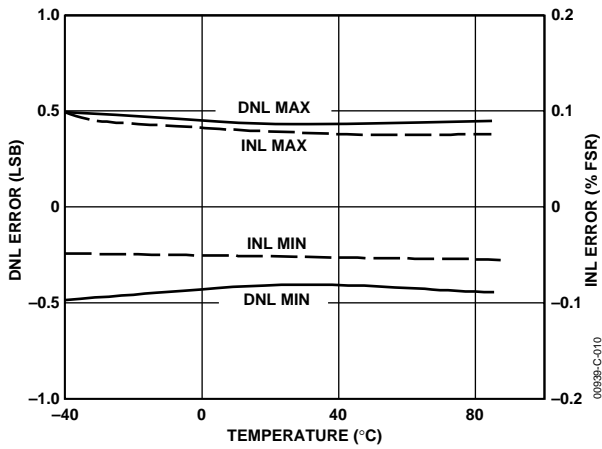

Figure 11. INL Error and DNL Error vs. Temperature

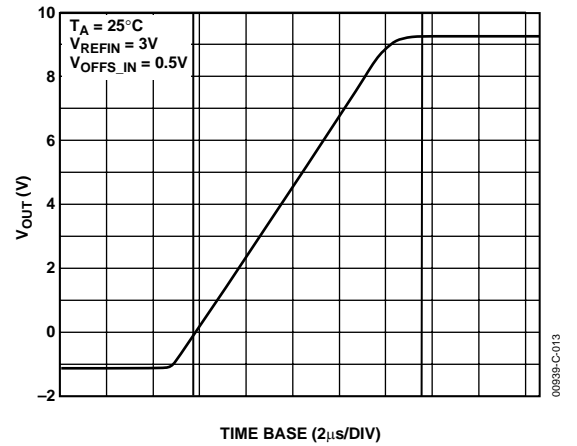

Figure 14. Full-Scale Settling Time

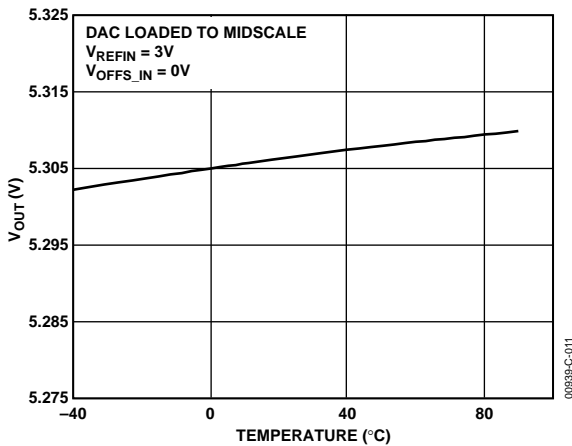

Figure 12.  $V_{out}$  vs. Temperature

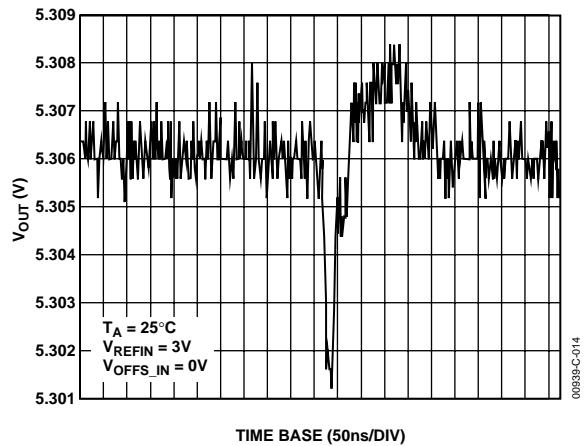

Figure 15. Major Code Transition Glitch Impulse

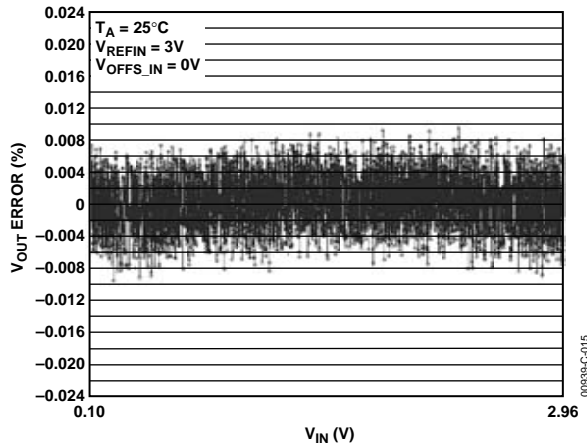

Figure 16.  $V_{IN}$  to  $V_{OUT}$  Accuracy after Offset and Gain Adjustment (ISHA Mode)

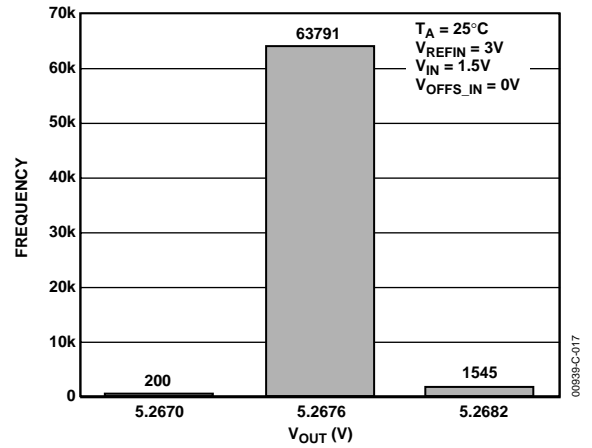

Figure 18. ISHA-Mode Repeatability (64 k Acquisitions)

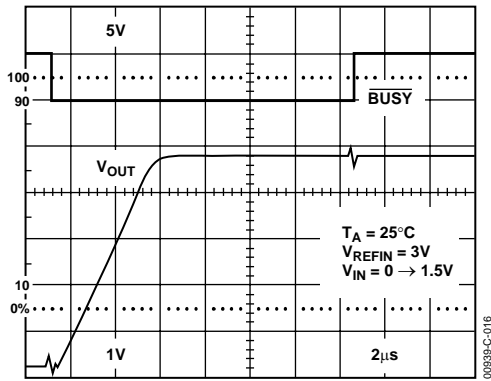

Figure 17. Acquisition Time and Output Settling Time (ISHA Mode)

## FUNCTIONAL DESCRIPTION

The AD5532 consists of 32 DACs and an ADC (for ISHA mode) in a single package. In DAC mode, a 14-bit digital word is loaded into one of the 32 DAC Registers via the serial interface. This is then converted (with gain and offset) into an analog output voltage ( $V_{OUT0}$ – $V_{OUT31}$ ).

To update a DAC's output voltage, the required DAC is addressed via the serial port. When the DAC address and code have been loaded, the selected DAC converts the code.

At power-on, all the DACs, including the offset channel, are loaded with zeros. Each of the 33 DACs is offset internally by 50 mV (typ) from GND, so the outputs  $V_{OUT0}$  to  $V_{OUT31}$  are 50 mV (typ) at power-on if the OFFS\_IN pin is driven directly by the on-board offset channel (OFFS\_OUT), i.e. if OFFS\_IN is 50 mV,  $V_{OUT} = (\text{Gain} \times V_{DAC}) - (\text{Gain} - 1) \times V_{OFFS\_IN} = 50 \text{ mV}$ .

### OUTPUT BUFFER STAGE—GAIN AND OFFSET

The function of the output buffer stage is to translate the 50 mV–3 V output of the DAC to a wider range. This is done by gaining up the DAC output by 3.52/7 and offsetting the voltage by the voltage on OFFS\_IN pin.

#### AD5532-1/AD5532-3/AD5532-5:

$$V_{OUT} = 3.52 \times V_{DAC} - 2.52 \times V_{OFFS\_IN}$$

#### AD5532-2:

$$V_{OUT} = 7 \times V_{DAC} - 6 \times V_{OFFS\_IN}$$

$V_{DAC}$  is the output of the DAC.

$V_{OFFS\_IN}$  is the voltage at the OFFS\_IN pin.

The following table shows how the output range on  $V_{OUT}$  relates to the offset voltage supplied by the user.

**Table 8. Sample Output Voltage Ranges**

$V_{OFFS\_IN}$ (V)	$V_{DAC}$ (V)	$V_{OUT}$ (AD5532-1/-3/-5)	$V_{OUT}$ (AD5532-2)
0.5	0.05 to 3	–1.26 to +9.3	Headroom limited
1	0.05 to 3	–2.52 to +8.04	–6 to +15

$V_{OUT}$  is limited only by the headroom of the output amplifiers.  $V_{OUT}$  must be within maximum ratings.

### OFFSET VOLTAGE CHANNEL

The offset voltage can be externally supplied by the user at OFFS\_IN or it can be supplied by an additional offset voltage channel on the device itself. The offset can be set up in two ways. In ISHA mode, the required offset voltage is set up on  $V_{IN}$  and acquired by the offset channel. In DAC mode, the code corresponding to the offset value is loaded directly into the offset DAC. This offset channel's DAC output is directly connected to OFFS\_OUT. By connecting OFFS\_OUT to

OFFS\_IN this offset voltage can be used as the offset voltage for the 32 output amplifiers. It is important to choose the offset so that  $V_{OUT}$  is within maximum ratings.

### RESET FUNCTION

The reset function on the AD5532 can be used to reset all nodes on this device to their power-on reset condition. This is implemented by applying a low-going pulse of between 90 ns and 200 ns to the TRACK/RESET pin on the device. If the applied pulse is less than 90 ns, it is assumed to be a glitch and no operation takes place. If the applied pulse is wider than 200 ns, this pin adopts its track function on the selected channel,  $V_{IN}$  is switched to the output buffer, and an acquisition on the channel does not occur until a rising edge of TRACK.

### ISHA MODE

In ISHA mode, the input voltage  $V_{IN}$  is sampled and converted into a digital word. The noninverting input to the output buffer (gain and offset stage) is tied to  $V_{IN}$  during the acquisition period to avoid spurious outputs, while the DAC acquires the correct code. This is completed in 16  $\mu\text{s}$  max. The updated DAC output then assumes control of the output voltage. The output voltage of the DAC is connected to the noninverting input of the output buffer. Because the channel output voltage is effectively the output of a DAC, there is no droop associated with it. As long as power is maintained to the device, the output voltage is constant until this channel is addressed again. Because the internal DACs are offset by 70 mV (max) from GND, the minimum  $V_{IN}$  in ISHA mode is 70 mV. The maximum  $V_{IN}$  is 2.96 V due to the upper dead band of 40 mV (max).

### ANALOG INPUT (ISHA MODE)

Figure 19 shows the equivalent analog input circuit. The Capacitor C1 is typically 20 pF and can be attributed to pin capacitance and 32 off-channels. When a channel is selected, an extra 7.5 pF (typ) is switched in. This Capacitor C2 is charged to the previously acquired voltage on that particular channel so it must charge/discharge to the new level. The external source must be able to charge/discharge this additional capacitance within 1  $\mu\text{s}$ –2  $\mu\text{s}$  of channel selection so that  $V_{IN}$  can be acquired accurately. Thus, a low impedance source is suggested.

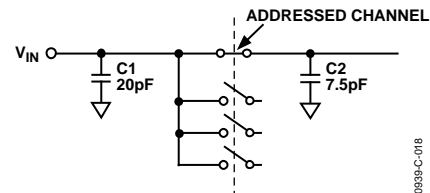

Figure 19. Analog Input Circuit

Large source impedances significantly affect the performance of the ADC. An input buffer amplifier may be required.

## TRACK FUNCTION (ISHA MODE)

Typically in ISHA mode of operation  $\overline{\text{TRACK}}$  is held high and the channel begins to acquire when it is addressed. However, if  $\overline{\text{TRACK}}$  is low when the channel is addressed,  $V_{\text{IN}}$  is switched to the output buffer and an acquisition on the channel does not occur until a rising edge of  $\overline{\text{TRACK}}$ . At this stage, the  $\overline{\text{BUSY}}$  pin goes low until the acquisition is complete, at which point the DAC assumes control of the voltage to the output buffer and  $V_{\text{IN}}$  is free to change again without affecting this output value.

This is useful in an application where the user wants to ramp up  $V_{\text{IN}}$  until  $V_{\text{OUT}}$  reaches a particular level (see Figure 20).  $V_{\text{IN}}$  does not need to be acquired continuously while it is ramping up.  $\overline{\text{TRACK}}$  can be kept low and only when  $V_{\text{OUT}}$  has reached its desired voltage is  $\overline{\text{TRACK}}$  brought high. At this stage, the acquisition of  $V_{\text{IN}}$  begins.

In the example shown, a desired voltage is required on the output of the pin driver. This voltage is represented by one input to a comparator. The microcontroller/microprocessor ramps up the input voltage on  $V_{\text{IN}}$  through a DAC.  $\overline{\text{TRACK}}$  is kept low while the voltage on  $V_{\text{IN}}$  ramps up so that  $V_{\text{IN}}$  is not continually acquired. When the desired voltage is reached on the output of the pin driver, the comparator output switches. The  $\mu\text{C}/\mu\text{P}$  then knows what code is required to be input to obtain the desired voltage at the DUT. The  $\overline{\text{TRACK}}$  input is now brought high and the part begins to acquire  $V_{\text{IN}}$ . At this stage  $\overline{\text{BUSY}}$  goes low until  $V_{\text{IN}}$  has been acquired. The output buffer is then switched from  $V_{\text{IN}}$  to the output of the DAC.

## MODES OF OPERATION

The AD5532 can be used in four different modes of operation. These modes are set by two mode bits, the first two bits in the serial word.

Table 9. Modes of Operation

Mode Bit 1	Mode Bit 2	Operating Mode
0	0	ISHA mode
0	1	DAC mode
1	0	Acquire and Read Back
1	1	Read Back

### 1. ISHA Mode

In this mode, a channel is addressed and that channel acquires the voltage on  $V_{\text{IN}}$ . This mode requires a 10-bit write (see Figure 21a) to address the relevant channel ( $V_{\text{OUT}0}$ – $V_{\text{OUT}31}$ , offset channel or all channels). MSB is written first.

### 2. DAC Mode

In this standard mode, a selected DAC register is loaded serially. This requires a 24-bit write (10 bits to address the relevant DAC plus an extra 14 bits of DAC data). MSB is written first. The user must allow 400 ns (min) between successive writes in DAC mode.

### 3. Acquire and Readback Mode

This mode allows the user to acquire  $V_{\text{IN}}$  and read back the data in a particular DAC register. The relevant channel is addressed (10-bit write, MSB first) and  $V_{\text{IN}}$  is acquired in 16  $\mu\text{s}$  (max). Following the acquisition, after the next falling edge of  $\overline{\text{SYNC}}$ , the data in the relevant DAC register is clocked out onto the  $D_{\text{OUT}}$  line in a 14-bit serial format. The full acquisition time must elapse before the DAC register data can be clocked out.

### 4. Readback Mode

Again, this is a Readback mode but no acquisition is performed. The relevant channel is addressed (10-bit write, MSB first) and on the next falling edge of  $\overline{\text{SYNC}}$ , the data in the relevant DAC register is clocked out onto the  $D_{\text{OUT}}$  line in a 14-bit serial format. The user must allow 400 ns (min) between the last  $\overline{\text{SCLK}}$  falling edge in the 10-bit write and the falling edge of  $\overline{\text{SYNC}}$  in the 14-bit read back. The serial write and read words can be seen in Figure 21.

This feature allows the user to read back the DAC register code of any of the channels. In DAC mode, this is useful in verification of write cycles. In ISHA mode, readback is useful if the system has been calibrated and the user wants to know what code in the DAC corresponds to a desired voltage on  $V_{\text{OUT}}$ . If this voltage is required again, the user can input the code directly to the DAC register without going through the acquisition sequence.

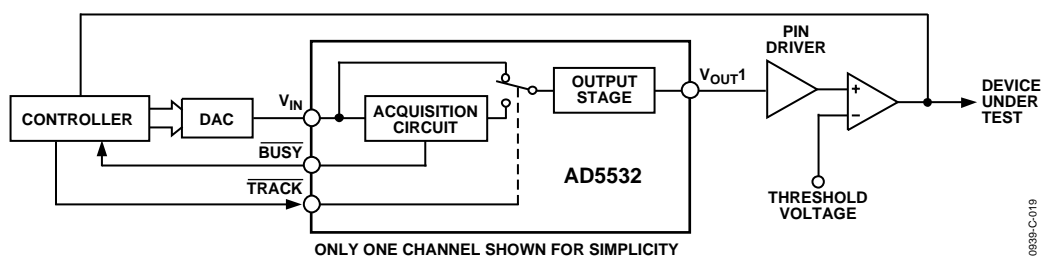

Figure 20. Typical ATE Circuit Using  $\overline{\text{TRACK}}$  Input

## SERIAL INTERFACE

The serial interface allows easy interfacing to most micro-controllers and DSPs, such as the PIC16C, PIC17C, QSPI, SPI, DSP56000, TMS320, and ADSP-21xx, without the need for any glue logic. When interfacing to the 8051, the SCLK must be inverted. The Microprocessor Interfacing section explains how to interface to some popular DSPs and microcontrollers. Figure 4, Figure 5, and Figure 6 show the timing diagram for a serial read and write to the AD5532. The serial interface works with both a continuous and a noncontinuous serial clock. The first falling edge of SYNC resets a counter that counts the number of serial clocks to ensure the correct number of bits are shifted in and out of the serial shift registers. Any further edges on SYNC are ignored until the correct number of bits are shifted in or out. Once the correct number of bits for the selected mode has been shifted in or out, the SCLK is ignored. In order for another serial transfer to take place the counter must be reset by the falling edge of SYNC.

In readback, the first rising SCLK edge after the falling edge of SYNC causes D<sub>OUT</sub> to leave its high impedance state and data is clocked out onto the D<sub>OUT</sub> line and also on subsequent SCLK rising edges. The D<sub>OUT</sub> pin goes back into a high impedance state on the falling edge of the 14th SCLK. Data on the D<sub>IN</sub> line is latched in on the first SCLK falling edge after the falling edge of the SYNC signal and on subsequent SCLK falling edges. During read-back D<sub>IN</sub> is ignored. The serial interface does

not shift data in or out until it receives the falling edge of the SYNC signal.

**Table 10**

Pin	Description
SER/PAR	This pin is tied high to enable the serial interface and to disable the parallel interface. The serial interface is controlled by the four pins that follow.
SYNC, D <sub>IN</sub> , SCLK	Standard 3-wire interface pins. The SYNC pin is shared with the CS function of the parallel interface.
D <sub>OUT</sub>	Data Out pin for reading back the contents of the DAC registers. The data is clocked out on the rising edge of SCLK and is valid on the falling edge of SCLK.
Mode Bits	The four different modes of operation are described in the Modes of Operation section.
Cal Bit	In DAC mode, this is a test bit. When high, it loads all 0s or all 1s to the 32 DACs simultaneously. In ISHA mode, all 32 channels acquire V <sub>IN</sub> at the same time when this bit is high. In ISHA mode, the acquisition time is then 45 μs (typ) and accuracy may be reduced. This bit is set low for normal use.
Offset Sel Bit	If this is set high, the offset channel is selected and Bits A4–A0 are ignored.
Test Bit	Must be set low for correct operation of the part.
A4–A0	Used to address any one of the 32 channels (A4 = MSB of address, A0 = LSB).
DB13–DB0	Used to write a 14-bit word into the addressed DAC register. Only valid when in DAC mode.

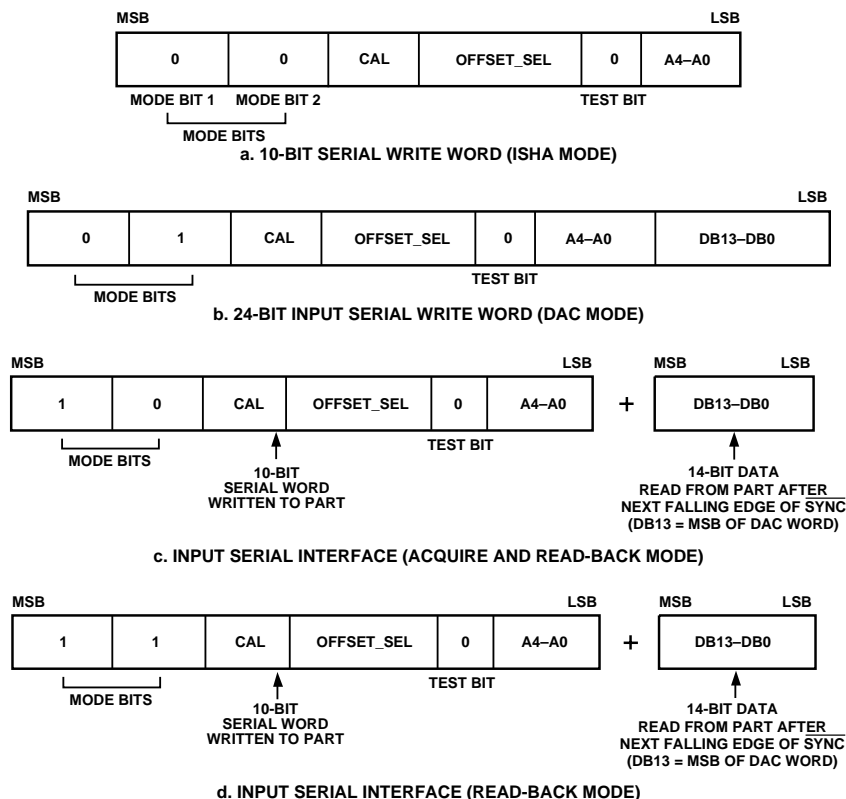

Figure 21. Serial Interface Formats

00599-C-020



## PARALLEL INTERFACE (ISHA MODE ONLY)

The SER/ $\overline{\text{PAR}}$  bit must be tied low to enable the parallel interface and disable the serial interface. The parallel interface is controlled by nine pins, as described in Table 11.

Table 11.

Pin	Description
$\overline{\text{CS}}$	Active low package select pin. This pin is shared with the $\overline{\text{SYNC}}$ function for the serial interface.
$\overline{\text{WR}}$	Active low write pin. The values on the address pins are latched on a rising edge of $\overline{\text{WR}}$ .
A4–A0	Five address pins (A4 = MSB of address, A0 = LSB). These are used to address the relevant channel (out of a possible 32).
OFFSET_SEL	Offset select pin. This has the same function as the Offset_Sel bit in the serial interface. When it is high, the offset channel is addressed. The address on A4–A0 is ignored in this case.
CAL	When this pin is high, all 32 channels acquire VIN simultaneously. The acquisition time is then 45 $\mu\text{s}$ (typ) and accuracy may be reduced.

## MICROPROCESSOR INTERFACING

### AD5532 to ADSP-21xx Interface

ADSP-21xx DSPs are easily interfaced to the AD5532 without the need for extra logic.

A data transfer is initiated by writing a word to the TX register after the SPORT has been enabled. In a write sequence, data is clocked out on each rising edge of the DSP serial clock and clocked into the AD5532 on the falling edge of its SCLK. In readback, 16 bits of data are clocked out of the AD5532 on each rising edge of SCLK and clocked into the DSP on the rising edge of SCLK.  $D_{\text{IN}}$  is ignored. The valid 14 bits of data is centered in the 16-bit RX register in this configuration. The SPORT Control register should be set up as in Table 12.

Table 12.

TFSW = RFSW = 1	Alternate framing
INVRFS = INVTFS = 1	Active low frame signal
DTYPE = 00	Right justify data
ISCLK = 1	Internal serial clock
TFSR = RFSR = 1	Frame every word
IRFS = 0	External framing signal
ITFS = 1	Internal framing signal
SLEN = 1001	10-bit data-words (ISHA mode write)
SLEN = 0111	3 × 8-bit data-words (DAC mode write)
SLEN = 1111	16-bit data-words (Readback mode)

Figure 22 shows the connection diagram.

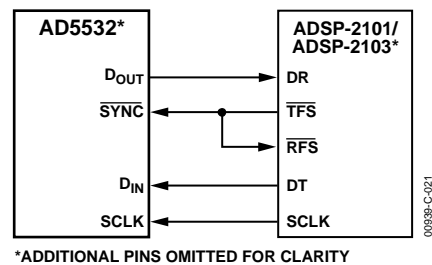

\*ADDITIONAL PINS OMITTED FOR CLARITY

Figure 22. AD5532 to ADSP-2101/ADSP-2103 Interface

### AD5532 to MC68HC11

The serial peripheral interface (SPI) on the MC68HC11 is configured for master mode (MSTR) = 1, clock polarity bit (CPOL) = 0, and the clock phase bit (CPHA) = 1. The SPI is configured by writing to the SPI control register (SPCR)—see the *68HC11 User Manual*. SCK of the 68HC11 drives the SCLK of the AD5532, the MOSI output drives the serial data line ( $D_{\text{IN}}$ ) of the AD5532, and the MISO input is driven from  $D_{\text{OUT}}$ . The  $\overline{\text{SYNC}}$  signal is derived from a port line (PC7). When data is being transmitted to the AD5532, the  $\overline{\text{SYNC}}$  line is taken low (PC7). Data appearing on the MOSI output is valid on the falling edge of SCK. Serial data from the 68HC11 is transmitted in 8-bit bytes with only eight falling clock edges occurring in the transmit cycle. Data is transmitted MSB first. To transmit 10 data bits in ISHA mode, it is important to left-justify the data in the SPDR register. PC7 must be pulled low to start a transfer. It is taken high and pulled low again before other read/write cycles can take place. Figure 23 shows a connection diagram.

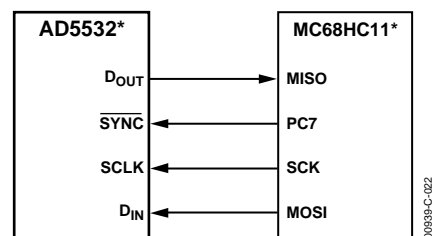

\*ADDITIONAL PINS OMITTED FOR CLARITY

Figure 23. AD5532 to MC68HC11 Interface

# AD5532

## AD5532 to PIC16C6x/7x

The PIC16C6x/7x synchronous serial port (SSP) is configured as an SPI master with the Clock Polarity Bit = 0. This is done by writing to the synchronous serial port control register (SSPCON). See the *PIC16/17 Microcontroller User Manual*. In this example, the I/O port RA1 is being used to pulse SYNC and enable the serial port of the AD5532. This microcontroller transfers only eight bits of data during each serial transfer operation; therefore, two or three consecutive read/write operations are needed depending on the mode. Figure 24 shows the connection diagram.

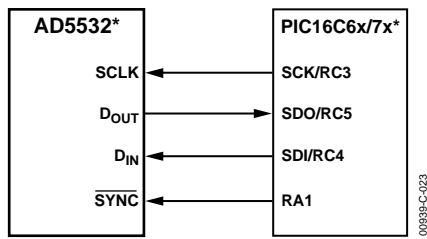

Figure 24. AD5532 to PIC16C6x/7x Interface

## AD5532 to 8051

The AD5532 requires a clock synchronized to the serial data. The 8051 serial interface must therefore be operated in Mode 0. In this mode, serial data enters and exits through RxD and a shift clock is output on TxD. Figure 25 shows how the 8051 is connected to the AD5532. Because the AD5532 shifts data out on the rising edge of the shift clock and latches data in on the falling edge, the shift clock must be inverted. The AD5532 requires its data with the MSB first. Because the 8051 outputs the LSB first, the transmit routine must take this into account.

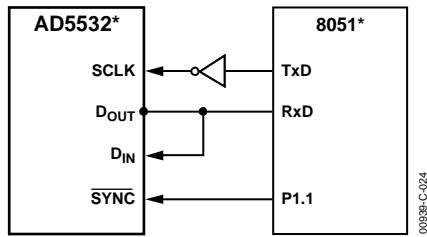

Figure 25. AD5532 to 8051 Interface

## APPLICATION CIRCUITS

### AD5532 in a Typical ATE System

The AD5532 is ideally suited for use in automatic test equipment. Several DACs are required to control pin drivers, comparators, active loads, and signal timing. Traditionally, sample-and-hold devices were used in this application.

The AD5532 has several advantages: no refreshing is required, there is no droop, pedestal error is eliminated, and there is no need for extra filtering to remove glitches. Overall a higher level of integration is achieved in a smaller area (see Figure 26).

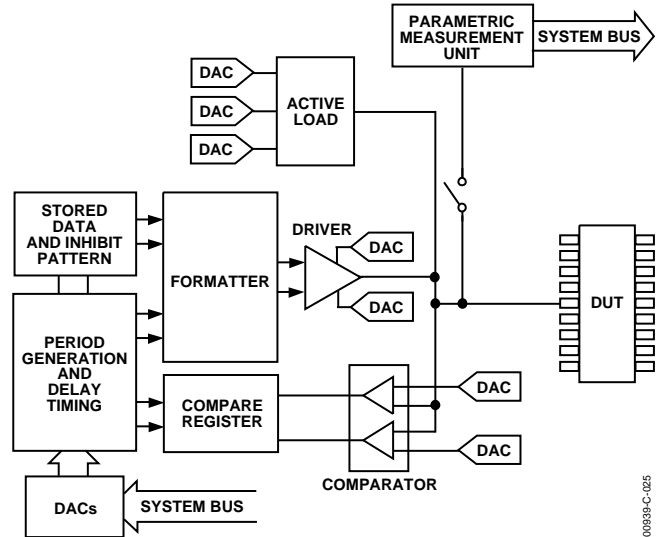

Figure 26. AD5532 in an ATE System

### Typical Application Circuit (DAC Mode)

The AD5532 can be used in many optical networking applications that require a large number of DACs to perform control and measurement functions. In the example shown in Figure 27, the outputs of the AD5532 are amplified and used to control actuators that determine the position of MEMS mirrors in an optical switch. The exact position of each mirror is measured using sensors. The sensor readings are muxed using four dual, 4-channel matrix switches (ADG739) and fed back to an 8-channel, 14-bit ADC (AD7856).

The control loop is driven by an ADSP-2191M, a 16-bit fixed-point DSP with 3 SPORT interfaces and 2 SPI ports. The DSP uses some of these serial ports to write data to the DAC, control the multiplexer, and read back data from the ADC.

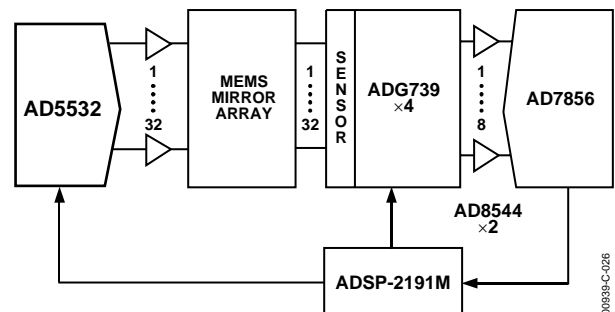

Figure 27. Typical Optical Control and Measurement Application Circuit

### Typical Application Circuit (ISHA Mode)

The AD5532 can be used to set up voltage levels on 32 channels as shown in the circuit that follows. An AD780 provides the 3 V reference for the AD5532 and for the AD5541 16-bit DAC. A simple 3-wire interface is used to write to the AD5541. Because the AD5541 has an output resistance of 6.25 k $\Omega$ (typ), the time taken to charge/discharge the capacitance at the  $V_{IN}$  pin is significant. Hence an AD820 is used to buffer the DAC output. Note that it is important to minimize noise on  $V_{IN}$  and  $REF_{IN}$  when laying out the circuit.

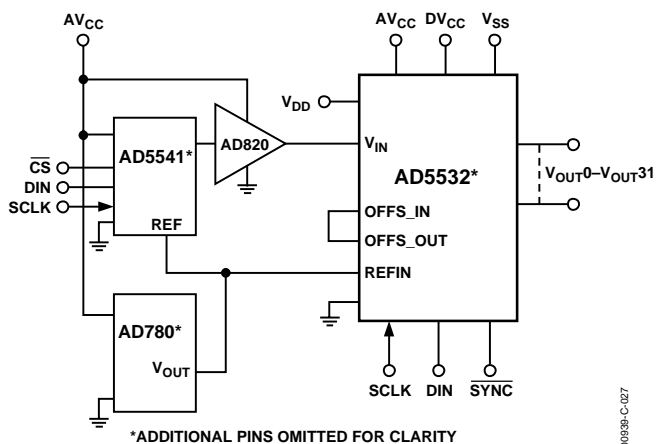

Figure 28. Typical Application Circuit (ISHA Mode)

### POWER SUPPLY DECOUPLING

In any circuit where accuracy is important, careful consideration of the power supply and ground return layout helps to ensure the rated performance. The printed circuit board on which the AD5532 is mounted should be designed so that the analog and digital sections are separated and confined to certain areas of the board. If the AD5532 is in a system where multiple devices require an AGND-to-DGND connection, the connection should be made at one point only. The star ground point should be established as close as possible to the device. For supplies with multiple pins ( $V_{SS}$ ,  $V_{DD}$ ,  $AV_{CC}$ ) it is recommended to tie those pins together. The AD5532 should have ample supply bypassing of 10  $\mu\text{F}$  in parallel with 0.1  $\mu\text{F}$  on each supply located as close to the package as possible, ideally right up against the device. The 10  $\mu\text{F}$  capacitors are the tantalum bead type. The 0.1  $\mu\text{F}$  capacitor should have low effective series resistance (ESR) and effective series inductance (ESI), such as the common ceramic types that provide a low impedance path to ground at high frequencies, to handle transient currents due to internal logic switching.

The power supply lines of the AD5532 should use as large a trace as possible to provide low impedance paths and reduce the effects of glitches on the power supply line. Fast switching signals, such as clocks, should be shielded with digital ground to avoid radiating noise to other parts of the board and should never be run near the reference inputs. A ground line routed between the  $D_{IN}$  and SCLK lines helps reduce crosstalk between them (not required on a multilayer board as there is a separate ground plane, but separating the lines helps).

Note it is essential to minimize noise on  $V_{IN}$  and  $REF_{IN}$  lines. Particularly for optimum ISHA performance, the  $V_{IN}$  line must be kept noise free. Depending on the noise performance of the board, a noise filtering capacitor may be required on the  $V_{IN}$  line. If this capacitor is necessary, then for optimum throughput it may be necessary to buffer the source which is driving  $V_{IN}$ . Avoid crossover of digital and analog signals. Traces on opposite sides of the board should run at right angles to each other. This reduces the effects of feedthrough through the board. A microstrip technique is by far the best, but not always possible with a double-sided board. In this technique, the component side of the board is dedicated to ground plane while signal traces are placed on the solder side.

As is the case for all thin packages, care must be taken to avoid flexing the package and to avoid a point load on the surface of the package during the assembly process.

OUTLINE DIMENSIONS

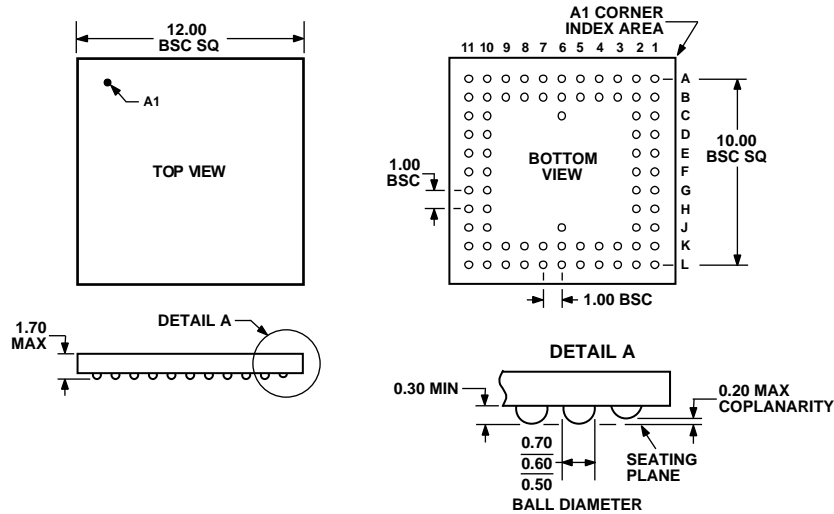

COMPLIANT TO JEDEC STANDARDS MO-192ABD-1

Figure 29. 74-Lead Chip Scale Ball Grid Array [CSPBGA] (BC-74)

Dimensions shown in millimeters

ORDERING GUIDE

Model	Temperature Range	Function	Output Impedance	Output Voltage Span	Package Description	Package Option
AD5532ABC-1	-40°C to +85°C	32 DACs, 32-channel ISHA	0.5 Ω typ	10 V	74-lead CSPBGA	BC-74
AD5532ABC-1REEL	-40°C to +85°C	32 DACs, 32-channel ISHA	0.5 Ω typ	10 V	74-lead CSPBGA	BC-74
AD5532ABC-2	-40°C to +85°C	32 DACs, 32-channel ISHA	0.5 Ω typ	20 V	74-lead CSPBGA	BC-74
AD5532ABC-3	-40°C to +85°C	32 DACs, 32-channel ISHA	500 Ω typ	10 V	74-lead CSPBGA	BC-74
AD5532ABC-3REEL	-40°C to +85°C	32 DACs, 32-channel ISHA	500 Ω typ	10 V	74-lead CSPBGA	BC-74
AD5532ABC-5	-40°C to +85°C	32 DACs, 32-channel ISHA	1 kΩ typ	10 V	74-lead CSPBGA	BC-74
AD5532ABC-5REEL	-40°C to +85°C	32 DACs, 32-channel ISHA	1 kΩ typ	10 V	74-lead CSPBGA	BC-74
EVAL-AD5532EB		Evaluation Board				